

ELIA AL S2 18W 60°

Part number GWF1410GH830

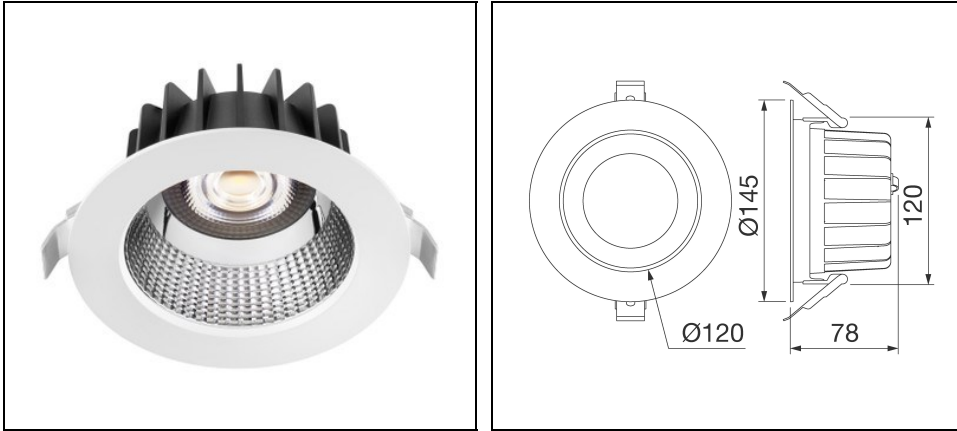

Description

Flush-mounting LED device for accent lighting in commercial areas and offices

- This modular flush-mounting solution features a rotosymmetrical optic equipped with a passive heat removal system, in die-cast aluminium
- It is composed of a white powder-coated die-cast aluminium frame and 2 different optics (36° and 60°) that guarantee a UGR of less than 19
- Installation is quick and easy, thanks to the reduced weight of the device, the bayonet coupling and the simple wiring, with the connector located on the device and remote power supply included
- External emergency kit with 3h autonomy available (to be ordered separately)

Product data

ETIM Group:	EG000027	ETIM Class:	EC001744
-------------	----------	-------------	----------

General information

Lampholder:	LED	Light source:	LED
Luminaire lumen output [lm]:	2000	Luminaire wattage [W]:	18 W
Luminous efficacy [lm/W]:	111	CRI:	80
Colour temperature [K]:	3000	Colour / Finishing:	WH-RAL9016 / White RAL9016
IP degree of protection:	IP40	IP above/below ceiling:	IP40/IP54
IK-J-xxIP:	IK06 1J xx3	Protection class:	II
Optic:	SYMM - Symmetric	Beam angle:	60°
Net weight [kg]:	0.59	Overall diameter [mm]:	145
Overall height [mm]:	78		

Mechanical features

Housing material:	Aluminium	Diffuser material:	Plastic
Glow wire test [°C]:	850 °C		

Electrical features

Voltage type:	AC	Input voltage [V AC]:	220/240
Input frequency [Hz]:	50/60		

Installation

Application area:	Indoor	Mounting type:	Recessed spotlights
Min. ambient temperature [°C]:	-20	Max. ambient temperature [°C]:	45

Light features

MacAdam:	3	Lumen maintenance:	L80B50@50000h
Distribution of light emission:	Direct	UGR max.:	19.0

Photometric data

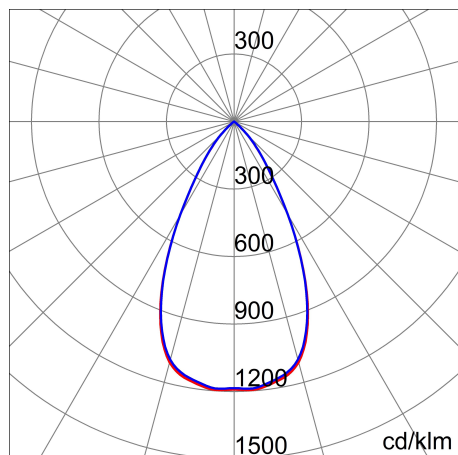

Optional accessories

ELIA AL



GWS2992
Emergency kit 3h